

TRAMONTINA



Utilidades e Móveis

Utilities and Furniture
Utilidades y Muebles

2023





UTILIDADES E MÓVEIS

Tramontina Madeiras tem a satisfação de apresentar seus produtos manufaturados em madeira maciça de pinus e também em outros materiais.

A utilização de processos tecnologicamente avançados – em uma fábrica moderna e bem equipada – aliada à experiência técnica e humana da equipe de profissionais que a compõem, garantem a regularidade e a qualidade dos produtos.

UTILITIES AND FURNITURE

Tramontina Madeiras is pleased to present their products manufactured using solid pinus wood and in other materials.

Using modern technologies – in a modern and well equipped factory – together with the technical and human experience of their professional staff, guarantees the exactness and quality of the products.

UTILIDADES Y MUEBLES

Tramontina Madeiras tiene la satisfacción de presentar sus productos en madera maciza de pinos y también en otros materiales.

La utilización de procesos tecnológicamente avanzados – e una fábrica moderna y bien equipada – unida a la experiencia técnica y humana del equipo de profesionales.



A EMPRESA

TRAMONTINA, O PRAZER DE FAZER BONITO.

Mais do que números, o que define a **Tramontina** é o esforço permanente em tornar a vida das pessoas cada vez melhor. A pequena ferraria fundada por Valentin e Elisa Tramontina em 1911, no sul do Brasil, deu origem a um grupo que hoje conta com 9 unidades fabris e mantém a vocação centenária de encantar com gestos simples.

O segredo para manter a essência está em acreditar nas pessoas. A Tramontina valoriza cada um dos mais de 9 mil funcionários para que entreguem ao mercado produtos funcionais e com estilo, que inspiram o dia a dia e estimulam experiências para gerar valor e satisfação a clientes, consumidores e comunidades.

Tudo isso é traduzido nos mais de 18 mil itens que carregam valores de uma marca única. Utensílios e equipamentos para cozinha, eletros, ferramentas para agricultura, jardinagem, manutenção industrial e automotiva, construção civil, materiais elétricos, móveis de madeira ou de plástico, além da ampla linha de equipamentos dirigíveis são fabricados para o mercado nacional e exportados para mais de 120 países.

É no fazer bonito que a Tramontina e as pessoas se encontram. Atuando de forma global, a marca tem o suporte necessário para entregar soluções capazes de atender as necessidades de seu tempo, aliando produtividade e superação de metas ao desenvolvimento sustentável através do programa de gestão ambiental. Muito prazer, Tramontina!

THE COMPANY

TRAMONTINA, BEAUTIFULLY WELL DONE.

More than just numbers, what truly defines Tramontina is the constant effort to make people's lives better. The small iron mill founded by Valentin and Elisa Tramontina in 1911 in southern Brazil was the beginning of a group that now encompasses 9 manufacturing units and has kept the century-old tradition of delighting people with simple gestures.

The secret for maintaining this essence is believing in people. Tramontina values each one of its over 9,000 employees so they can deliver functional, stylish products to the market, bringing inspiration to people's daily living and creating experiences to generate value and satisfy clients, consumers and communities.

All this is apparent in the more than 18,000 items that carry the values of a unique brand. Kitchen utensils and equipment, appliances, tools for agriculture, gardening, industrial and automotive maintenance, construction, electrical hardware, wood and plastic furniture, and a wide range of ride-on equipment is manufactured for the domestic market and exported to over 120 countries.

It is by doing beautiful things well that Tramontina and people are brought together. A global player, the company finds the necessary support to deliver solutions that can meet contemporary demands, combining productivity and going over and beyond targets for sustainable development through the environmental management program.

Pleased to meet you, Tramontina!

LA EMPRESA

TRAMONTINA, EL PLACER DE HACER BIEN LAS COSAS.

Más que números, lo que define a Tramontina es el esfuerzo permanente para mejorar cada vez más la vida de la gente. La pequeña herrería fundada por Valentin y Elisa Tramontina en 1911, en el sur de Brasil, originó un grupo que hoy cuenta con 9 unidades fabriles y mantiene la vocación centenaria de encantar con gestos sencillos.

El secreto para mantener la esencia es creer en las personas. Tramontina valora a cada uno de los más de 9 mil empleados para que le entreguen al mercado productos funcionales y con estilo, que inspiran el día a día y estimulan experiencias para generar valor y satisfacción a clientes, consumidores y comunidades.

Todo eso se traduce en los más de 18 mil artículos que llevan los valores de una marca única. Utensilios y equipos de cocina, electrodomésticos, herramientas para agricultura, jardinería, mantenimiento industrial y automovilístico, construcción civil, materiales eléctricos, muebles de madera o de plástico, además de la amplia línea de equipos dirigibles, que se fabrican para el mercado nacional y de exportación para más de 120 países.

Es en el hacer bien las cosas que se encuentran Tramontina y las personas. Actuando de forma global, la marca tiene el soporte necesario para entregar soluciones capaces de atender las necesidades de su tiempo, aliando productividad y superación de metas de desarrollo sustentable por medio del programa de gestión ambiental.

¡Encantada, Tramontina!



Unidade Fabril MADEIRAS | MADEIRAS Industrial Unit | Unidad Fabril MADEIRAS

TRAMONTINA MADEIRAS

Tramontina Madeiras, fundada em 1990, está localizada em Encruzilhada do Sul, RS.

Hoje, com aproximadamente 32.900 m² de área construída, esta unidade fabril conta com cerca de 260 funcionários que se ocupam de um mix de produtos em madeira, destinados à organização e à decoração da casa: mesas, bancos, banquetas, prateleiras, estantes e painéis, além de mesas de passar, varais, bandejas e componentes com qualidade e excelente acabamento.

O design prático, funcional e colorido é um importante diferencial dos produtos, que vão colaborar na organização da casa para o consumidor fazer bonito no seu dia a dia.

TRAMONTINA MADEIRAS

Tramontina Madeiras was founded in 1990 and is located in Encruzilhada do Sul, in the state of Rio Grande do Sul.

It now has an industrial area of over 32.900 m² and 200 employees who manufacture a wide range of wood products for decoration as well as domestic utensils such as tables, benches, stools, shelves, shelving units, panels, ironing boards, drying racks, trays, and other high-quality components which all have an excellent finish.

The practical, functional, and colorful design is an important distinguishing feature of the products that will help customers organize their homes and do things beautifully well every day.

TRAMONTINA MADEIRAS

Tramontina Madeiras, fundada en 1990, está ubicada en Encruzilhada do Sul, Rio Grande do Sul.

Esta unidad fabril, que hoy cuenta con 32.900 m² de área construida, tiene 200 empleados que se ocupan de un mix de productos de madera, destinados a la organización y decoración de la casa: mesas, bancos, banquetas, estantes, estanterías y paneles, además de tablas de planchar, tendederos, bandejas y componentes de excelente calidad y terminación.

El diseño prático, funcional y colorido es un diferencial importante de los productos que colaboran en la organización de la casa para que el consumidor se luzca en su día a día.

Conheça os cenários para uma vida prática e organizada.

Check out the scenarios for a practical, organized life.
Conoce los escenarios de una vida práctica y organizada.

[1]

11 DOBRÁVEIS
FOLDING | PLEGABLE

14 BAÚ
CHEST | BAÚL

16 BANDEJAS
TRAYS | BANDEJAS

[2]

21 BANQUETAS NATURALLE
STOOLS NATURALLE
TABURETES NATURALLE

25 CABIDES
HANGERS | PERCHEROS

29 PRATELEIRAS
SHELVES | ESTANTE

34 PAINÉIS FLOREIRA
WALL PLANTER | PANEL FLORERA

33 CUBOS
FOLDING | PLEGABLE

37 CASCAS DE PINUS
PINE BARK | CORTEZA DE PINO

41 SUPORTE PARA VASOS
SUPPORT FOR VASES | SOPORTE PARA MACETAS

42 ESTANTE MODULARE
MODULARE SHELVING
ESTANTERIA MODULARE

48 PAINÉIS
PANELS | PANELES

[3]

50 SUPORTES
BRACKETS | SOPORTES

55 VARAIS
DRYING RACK | TENDEDEROS

59 MESAS DE PASSAR
IRONING BOARDS | MESAS DE PLANCHAR

61 CESTOS
BASKETS | CESTOS

62 ORGANIZADORES DE PAREDE
WALL ORGANIZERS
ORGANIZADORES DE PARED

[1] organizando o dia a dia

organizing your daily living | organizando el día a día



[2] decorando a casa

decorating your home | decorando la casa



[3] otimizando a área de serviço

optimizing your utility room | optimizando el área de servicio



ORGANIZANDO O DIA A DIA

organizing your daily living | organizando el día a día







CONJUNTO DOBRÁVEL

Para organizar reuniões
com amigos e familiares.

folding set

For get-togethers
with family and friends.

juego plegable

Para organizar reuniones
con amigos y familiares.



conjunto dobrável naturalle rústico

Set Table and Benches Naturalle
Conjunto de Mesa y Bancos Naturalle

• madeira maciça	• solid wood mader maciza
• pés dobráveis	• folding legs patas plegables

REF.	mm	COR COLOR COLOR
91756/101	L 1988 x P 1400 x A 746	garapa

01 mesa +
02 bancos



banco dobrável naturalle rústico

Folding Bench Naturalle
Banco Plegable Naturalle

• madeira maciça	• solid wood mader maciza
• pés dobráveis	• folding legs patas plegables
• suporta até 200kg	• supports up to 200 kg soporta hasta 200kg

REF.	mm	COR COLOR COLOR
91756/023	C 1988 x L 300 x A 485	garapa

SUPORTA ATÉ
200kg



mesa dobrável naturalle rústico

Folding Table Naturalle
Mesa Plegable Naturalle

• madeira maciça	• solid wood mader maciza
• pés dobráveis	• folding legs patas plegables

REF.	mm	COR COLOR COLOR
91756/028	C 1988 x L 800 x A 746	garapa





conjunto mesa e bancos naturalle

Set Table and Benches Naturalle
Conjunto de Mesa y Bancos Naturalle

• pinus maciço	• solid pinus wood pino macizo
----------------	----------------------------------

REF.	mm	COR COLOR COLOR
------	----	----------------------

91750/103	L 1300 x P 1372 x A 800	natural
-----------	-------------------------	---------



SUPORTA ATÉ
200kg

01 mesa +
02 bancos



conjunto mesa e bancos naturalle

Set Table and Benches Naturalle
Conjunto de Mesa y Bancos Naturalle

• pinus maciço	• solid pinus wood pino macizo
• pés dobráveis	• folding legs patas plegables

REF.	mm	COR COLOR COLOR
------	----	----------------------

91750/100	L 2000 x P 1372 x A 800	natural
-----------	-------------------------	---------

91754/100	L 2000 x P 1372 x A 800	branca white blanca
-----------	-------------------------	-------------------------

91757/100	L 2000 x P 1372 x A 800	verniz varnished barniz
-----------	-------------------------	-----------------------------



SUPORTA ATÉ
200kg

01 mesa +
02 bancos



mesa naturalle dobrável naturalle

Folding Table Naturalle
Mesa Plegable Naturalle

- pinus maciço
- sólido pinus wood | pino macizo
- pés dobráveis
- folding legs | patas plegables

REF.	mm	COR COLOR COLOR
91750/018	L 1300 x P 800 x A 800	natural
91750/028	L 2000 x P 800 x A 800	
91754/028	L 2000 x P 800 x A 800	branca white blanca
91757/028	L 2000 x P 800 x A 800	verniz varnished barniz



banco dobrável naturalle

Folding Bench Naturalle
Banco Plegable Naturalle

- pinus maciço
- sólido pinus wood | pino macizo
- pés dobráveis
- folding legs | patas plegables

REF.	mm	COR COLOR COLOR
91750/013	L 1100 x P 286 x A 480	natural
91750/023	L 2000 x P 286 x A 480	natural
91754/023	L 2000 x P 286 x A 480	branca white blanca
91757/023	L 2000 x P 286 x A 480	verniz varnished barniz



SUPOERTA ATÉ
200kg





mesa dobrável

Folding Table
Mesa Plegable

- pinus maciço
- suporte metálico dobrável para fixação
- solid pinus wood | pino macizo
- folding metal bracket for mounting to wall suporte metálico plegable para fijación

REF.	mm	COR COLOR COLOR
91734/074	L 750 x P 450 x A 140	branca white blanca

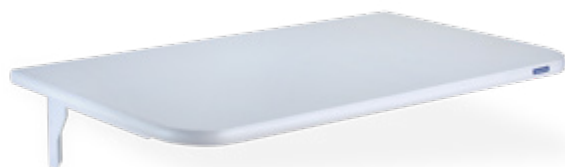

baú

Chest
Baúl

- pinus maciço
- capacidade: 85,5 litros
- solid pinus wood | pino macizo
- capacity: 85,5 liters | capacidad: 85,5 litros

REF.	mm	COR COLOR COLOR
91750/073	L 743 x P 336 x A 420	natural
91751/073	L 743 x P 336 x A 420	amarela yellow amarilla
91752/073	L 743 x P 336 x A 420	azul blue azul
91753/073	L 743 x P 336 x A 420	vermelha red roja
91754/073	L 743 x P 336 x A 420	branca white blanca





BANDEJAS

Acessório indispensável na casa e no trabalho. Apoio fundamental para os melhores momentos do seu dia.

trays

An indispensable accessory at home and at work. Perfect support for the best moments in your day.

bandejas

Accesorio indispensable en casa o en el trabajo. Apoyo fundamental para los mejores momentos de tu día.



bandeja happy day

Happy Day Tray
Bandeja Happy Day

- | | |
|--|--|
| <ul style="list-style-type: none"> • pinus maciço • pés dobráveis sem trava • laterais em polipropileno | <ul style="list-style-type: none"> • solid pinus wood pino macizo • folding legs without latch • patas plegables sin cerradura • polypropylene sides • laterales en polipropileno |
|--|--|

REF.	mm	COR COLOR COLOR
91390/002	L 608 x P 276 x A 200 [medida útil do tampo: 440 x 243]	natural cantoneira coral coral corner esquinero coral
91390/003		natural cantoneira camurça suede corner esquinero gamuza
91390/004		natural cantoneira branca white corner esquinero blanco
91390/008		natural cantoneira preta black corner esquinero negro



SUPORTA ATÉ
4kg





bandeja small

Small Tray
Bandeja Small

• pinus maciço	• solid pinus wood pino macizo
----------------	----------------------------------

REF.	mm	COR COLOR COLOR
91390/108	L 608 x P 272 x A 200 [medida útil do tampo: 443x245mm]	natural cantoneira preta black corner esquinero negro
91394/108		natural cantoneira branca white corner esquinero blanco
91390/119		natural cantoneira grafite graphite corner esquinero grafito



SUPORTA ATÉ
4kg



DECORANDO A CASA

decorating your home | decorando la casa







BANQUETAS

Versáteis, leves e bonitas.
Para todos os momentos e
para combinar com outras
peças da decoração.

stools

Versatile, light and beautiful.
Perfect for any occasion,
matching other decorative items.

taburetes









Versátiles, livianas y bonitas.
Para todos los momentos y para combinar
con otras piezas de decoración.



banqueta naturalle alta

Stool Naturalle
Taburete Naturalle

• pinus maciço	• solid pinus wood pino macizo
----------------	----------------------------------

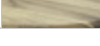
REF.	mm	COR COLOR COLOR	
91410/072	L 400 P 400 A 708	natural	
91411/072		amarela yellow amarilla	
91412/072		azul blue azul	
91413/072		vermelha red roja	
91414/072		branca white blanca	
91417/072		verniz varnished barniz	
91418/072		preta black negra	
91417/078		preto e verniz black and varnisher negra e barniz	
91417/178		garapa	



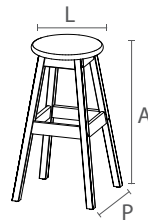





SUPORTA ATÉ
140kg



banqueta naturalle baixa

Stool Naturalle
Taburete Naturalle

• pinus maciço	• solid pinus wood pino macizo
----------------	----------------------------------

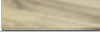
REF.	mm	COR COLOR COLOR	
91410/047	L 330 P 330 A 465	natural	
91411/047		amarela yellow amarilla	
91412/047		azul blue azul	
91413/047		vermelha red roja	
91414/047		branca white blanca	
91417/047		verniz varnished barniz	
91418/047		preta black negra	
91417/048		preto e verniz black and varnisher negra e barniz	
91417/148		garapa	

SUPORTA ATÉ
140kg

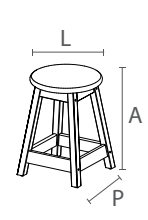



banqueta rústica alta

Rustic Stool
Taburete Rústica

• pinus maciço • solid pinus wood | pino macizo

REF.	mm	COR COLOR COLOR	
91411/172	L 400 P 400 A 708	amarela yellow amarilla	
91412/172		azul blue azul	
91413/172		vermelha red roja	
91414/172		branca white blanca	
91418/172		preta black negra	

SUPORTA ATÉ
140kg



banqueta rústica baixa

Rustic Stool
Taburete Rústica

• pinus maciço • solid pinus wood | pino macizo

REF.	mm	COR COLOR COLOR	
91411/147	L 330 P 330 A 465	amarela yellow amarilla	
91412/147		azul blue azul	
91413/147		vermelha red roja	
91414/147		branca white blanca	
91418/147		preta black negra	

SUPORTA ATÉ
140kg



banqueta naturalle vin alta

Stool Naturalle Vin
Taburete Naturalle Vin

• pinus maciço	• solid pinus wood pino macizo
• assento forrado em courvin	• asiento forrado en cuerina stool with synthetic leather lining

REF.	mm	COR COLOR COLOR	
91442/072	L 400 P 400 A 708	cinza gray gris	
91444/072		branca white blanca	
91448/072		preta black negra	
91449/072		camurça suede gamuza	

SUPORTA ATÉ





140kg



banqueta naturalle vin baixa

Stool Naturalle Vin
Taburete Naturalle Vin

• pinus maciço	• solid pinus wood pino macizo
• assento forrado em courvin	• asiento forrado en cuerina stool with synthetic leather lining

REF.	mm	COR COLOR COLOR	
91442/047	L 330 P 330 A 465	cinza gray gris	
91444/047		branca white blanca	
91448/047		preta black negra	
91449/047		camurça suede gamuza	

SUPORTA ATÉ

140kg





CABIDES

**Acessórios super úteis e bonitos!
O usuário escolhe a melhor composição.
Muito práticos, eles não podem faltar na casa.**

hangers

**Very useful and beautiful accessories!
The user chooses the best composition.
Very convenient, they are a must in the house**

percheros









**¡Accesorios muy útiles y bonitos!
El usuario elige la mejor composición.
Muy prácticos, no pueden faltar en la casa.**

cabide gancho

Hook Hanger

Gancho para Colgar

<ul style="list-style-type: none"> • pinus maciço • acompanham parafusos e buchas 	<ul style="list-style-type: none"> • solid pinus wood pino macizo • screws and fittings included acompañan tornillos y cojinetes
---	---

REF.	mm	COR COLOR COLOR	
91470/060	Ø60 x P 53	natural	
91474/060		branco white blanco	
91477/060		verniz varnished barniz	
91478/060		preto black negro	
91470/120	Ø120 x P 53	natural	
91474/120		branco white blanco	
91477/120		verniz varnished barniz	
91478/120		preto black negro	



SUPORTA ATÉ

8kg





cabide de apoio

Support Hanger
Percha de Apoio

<ul style="list-style-type: none"> • madeira de pinus maciça • Produto montado • Acompanha parafuso e bucha para fixação • Hastes móveis • Não possui trava nas hastes 	<ul style="list-style-type: none"> • solid pinus wood pino macizo • produto montado • assembled product producto armado • screws and bushings are included for wall se incluye tornillo y buje para fijación en la pared • there is no lock on the stems no posee traba en los ejes
---	--

REF.	mm	COR COLOR COLOR
91477/042	C 420 x L 30 x P149	verniz varnished barniz



SUPORTA ATÉ
2kg
POR HASTE





PRATELEIRAS

Soluções para organizar e decorar todos os ambientes da sua casa!

Diversidade em modelos, tamanhos, cores e suportes. Acompanham parafusos e buchas para instalação.



shelves

Solutions for organizing and decorating all the rooms in your home.

Variety of models, sizes, colors and mounting brackets. Screws and wall plugs for mounting included.

estantes

Soluciones para organizar y decorar todos los ambientes de tu casa.

Diversidad de modelos, tamaños, colores y soportes. Vienen con tornillos y tacos de fijación para su instalación.

prateleira elite – suporte invisível

Elite Shelf | Hidden Bracket
Estante Elite | Soporte Invisible

• acompanham parafusos e buchas	• screws and fittings included acompanñan tornillos y cojinetes
---------------------------------	--

REF.	mm		COR COLOR COLOR	
91273/065	L 600			
91273/095	900	P 250	A 25	maple
91273/125	1200			
91274/065	600			
91274/095	900	P 250	A 25	branca white blanca
91274/125	1200			
91275/065	600			
91275/095	900	P 250	A 25	amêndoa almond almendra
91275/125	1200			
91276/065	600			
91276/095	900	P 250	A 25	tabaco tobacco tabaco
91276/125	1200			
91277/065	600			
91277/095	900	P 250	A 25	noce brianza
91277/125	1200			

SUPOSTA ATÉ
10kg

SUPOSTA ATÉ
10kg

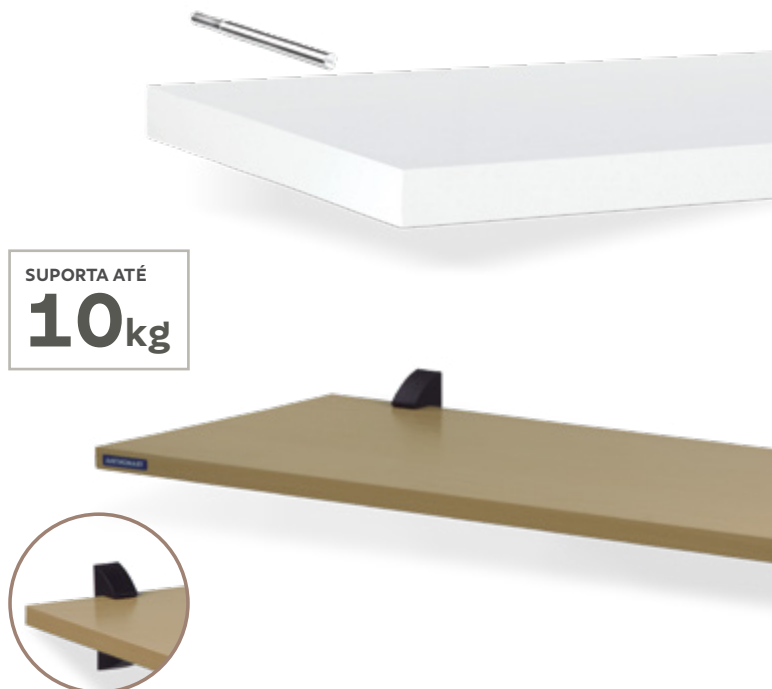

prateleira elite – suporte injetado

Elite Straight Shelf | Injected Bracket
Estante Elite | Soporte Inyectado

• acompanham parafusos e buchas	• screws and fittings included acompanñan tornillos y cojinetes
---------------------------------	--

	REF.	mm		COR COLOR COLOR	
SUPORTE BRANCO WHITE BRACKET SOPORTE BLANCO	91283/041	L 400	P 250	A 15	maple
	91283/061	600			
	91283/091	900			
	91283/121	1200			
	91284/041	400	P 250	A 15	branca white blanca
	91284/061	600			
	91284/091	900			
	91284/121	1200			
	91285/041	400	P 250	A 15	amêndoa almond almendra
91285/061	600				
91285/091	900				
91285/121	1200				
SUPORTE PRETO BLACK BRACKET SOPORTE NEGRO	91286/041	400	P 250	A 15	tabaco tobacco tabaco
	91286/061	600			
	91286/091	900			
	91286/121	1200			
	91287/041	400	P 250	A 15	noce brianza
	91287/061	600			
	91287/091	900			
	91287/121	1200			





SUPOSTA ATÉ
10kg



prateleira elite – suporte metálico

Elite Straight Shelf Metallic Bracket

Estante Elite Soporte Metálico

• acompanham parafusos e buchas	• screws and fittings included acompañan tornillos y cojinetes
---------------------------------	---

REF.	mm		COR COLOR COLOR
91283/047	L 400	P 250 A 15	maple
91283/067	600		
91283/097	900		
91283/127	1200		
91284/047	400	P 250 A 15	branca white blanca
91284/067	600		
91284/097	900		
91284/127	1200		
91285/047	400	P 250 A 15	amêndoa almond almendra
91285/067	600		
91285/097	900		
91285/127	1200		
91286/047	400	P 250 A 15	tabaco tobacco tabaco
91286/067	600		
91286/097	900		
91286/127	1200		
91287/047	400	P 250 A 15	noce brianza
91287/067	600		
91287/097	900		
91287/127	1200		

prateleira reta

Straight Shelf Wood Bracket

Estante Recta Soporte Madera

• suporte de pinus maciço	• solid pinus wood bracket soporte de madera maciza
• acompanha parafusos e buchas	• screws and fittings included acompañan tornillos y cojinetes

REF.	mm	COR COLOR COLOR
91240/042	L 400 x P 200 x A 18	natural
91240/062	L 600 x P 200 x A 18	
91240/092	L 900 x P 200 x A 18	
91240/122	L 1200 x P 200 x A 18	mel honey miel
91241/042	L 400 x P 200 x A 18	
91241/062	L 600 x P 200 x A 18	
91241/092	L 900 x P 200 x A 18	
91241/122	L 1200 x P 200 x A 18	branca white blanca
91244/042	L 400 x P 200 x A 18	
91244/062	L 600 x P 200 x A 18	
91244/092	L 900 x P 200 x A 18	
91244/122	L 1200 x P 200 x A 18	tabaco tobacco tabaco
91246/042	L 400 x P 200 x A 18	
91246/062	L 600 x P 200 x A 18	
91246/092	L 900 x P 200 x A 18	
91246/122	L 1200 x P 200 x A 18	

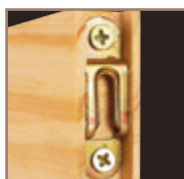





SUPOSTA ATÉ
10kg

prateleira canto suporte madeira

Corner Shelf Wood Bracket

Estante de Rincón Soporte Madera

• suporte de pinus maciço	• solid pinus wood bracket
• acompanham parafusos e buchas	• suporte de madeira maciza
	• screws and fittings included
	• acompanñan tornillos y cojinetes

REF.	mm	COR COLOR COLOR	
91200/002	L 200 x P 200 x A 18	natural	
91200/003	L 300 x P 300 x A 18		
91200/004	L 400 x P 400 x A 18		
91201/002	L 200 x P 200 x A 18	mel honey miel	
91201/003	L 300 x P 300 x A 18		
91201/004	L 400 x P 400 x A 18		
91204/002	L 200 x P 200 x A 18	branca white blanca	
91204/003	L 300 x P 300 x A 18		
91204/004	L 400 x P 400 x A 18		
91206/002	L 200 x P 200 x A 18	tabaco tobacco tabaco	
91206/003	L 300 x P 300 x A 18		
91206/004	L 400 x P 400 x A 18		



SUPORTA ATÉ
10kg



prateleira glass

Glass Shelf

Estante Glass

• suporte injetado	• plastic bracket soporte plastico
• acompanham parafusos e buchas	• screws and fittings included
	• acompanñan tornillos y cojinetes

	REF.	mm	COR COLOR COLOR
CANTO CORNER RINCÓN	91220/002	L 200 x P 200 x A 08	transparente
	91220/003	L 300 x P 300 x A 08	
	91220/025	L 250 x P 250 x A 08	
RETA STRAIGHT RECTA	91220/410	L 400 x P 100 x A 08	transparente
	91220/415	L 400 x P 150 x A 08	
	91220/420	L 400 x P 200 x A 08	
	91220/510	L 500 x P 100 x A 08	
	91220/515	L 500 x P 150 x A 08	
	91220/520	L 500 x P 200 x A 08	
	91220/610	L 600 x P 100 x A 08	
	91220/615	L 600 x P 150 x A 08	
QUADRA QUADRA QUADRA	91221/002	L 200 x P 200 x A 08	transparente
	91221/003	L 300 x P 300 x A 08	
	91221/025	L 250 x P 250 x A 08	

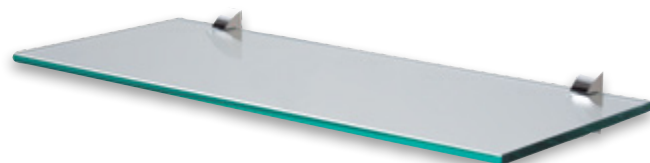

SUPORTA ATÉ
7kg



prateleira econômica

Economic Shelf
Estante Economica

- suporte de pinus maciço
- acompanham parafusos e buchas
- solid pinus wood bracket
- soporte de madera maciza
- screws and fittings included
- acompañan tornillos y cojinetes

REF.	mm	COR COLOR COLOR	
91240/052	L 500 x P 190 x A 18	natural	
91244/052	L 500 x P 190 x A 18	branca white blanca	
91246/052	L 500 x P 190 x A 18	tabaco tobacco tabaco	

SUPORTA ATÉ
10kg

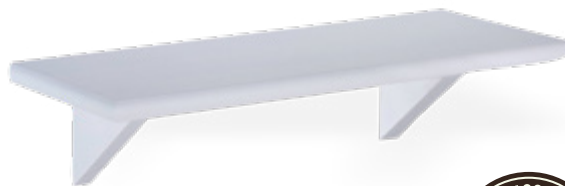

prateleira suporte para fornos

Support Shelf for Ovens
Estante para Hornos

- suporte metálico
- acompanham parafusos e buchas
- metalic bracket | soporte metálico
- screws and fittings included
- acompañan tornillos y cojinetes

REF.	mm	COR COLOR COLOR	
91284/645	L 600 x P 450 x A 18	branca white blanca	

SUPORTA ATÉ
25kg



cubos

Cubes
Cubos

• acompanham parafusos e buchas	• screws and fittings included acompañan tornillos y cojinetes
---------------------------------	---

REF.	mm	COR COLOR COLOR
91774/002	L 258 x P 220 x A 258	branca white blanca
91774/003	L 300 x P 220 x A 300	
91776/002	L 258 x P 220 x A 258	tabaco tobacco tabaco
91776/003	L 300 x P 220 x A 300	

SUPORTA ATÉ
10kg



kit frescobol

Frescoball Kit
Kit Frescobol

• pinus maciço	• solid pinus wood pino macizo
• bola de borracha	• rubber ball pelota de goma

REF.	mm	COR COLOR COLOR
91900/071	L 410 x P 220 x A 55,5	natural





painel floreira horizontal

Wall Planter
Panel Florera

- pinus maciço
- acompanham parafusos e buchas
- não acompanha acessórios e ferragens para pendurar.
- solid pinus wood | pino macizo
- screws and fittings included
- acompañan tornillos y cojinetes
- accessories and hardware for hanging not included | no viene con accesorios ni herrajes para colgar

REF.	mm	COR COLOR COLOR
91150/100	C 1000 x L 560 x P 36	natural



SUPORTA ATÉ
20kg



painel floreira horizontal com prateleiras

Shelf Wall Planter
Panel Florera con Estantes

- pinus maciço
- acompanham parafusos e buchas
- solid pinus wood | pino macizo
- screws and fittings included
- acompañan tornillos y cojinetes

REF.	mm	COR COLOR COLOR
91150/110	C 1000 x L 560 x P 226	natural



SUPORTA ATÉ
20kg
POR PRATELEIRA



painel floreira vertical

Vertical Wall Planter
Panel Florera Vertical

- pinus maciço
- acompanham parafusos e buchas
- não acompanha acessórios e ferragens para pendurar.
- solid pinus wood | pino macizo
- screws and fittings included
- acompañan tornillos y cojinetes
- accessories and hardware for hanging not included | no viene con accesorios ni herrajes para colgar

REF.	mm	COR COLOR COLOR
91150/101	C 560 x L 1000 x P 36	natural



SUPORTA ATÉ
20kg



painel floreira vertical com prateleiras

Shelf Vertical Wall Planter
Panel Florera Vertical con Estantes

- pinus maciço
- acompanham parafusos e buchas
- solid pinus wood | pino macizo
- screws and fittings included
- acompañan tornillos y cojinetes

REF.	mm	COR COLOR COLOR
91150/111	C 560 x L 1000 x P 226	natural



SUPORTA ATÉ
20kg
POR PRATELEIRA





CASCAS DE PINUS

Quem ama cuidar do jardim,
sabe da importância de oferecer o que
há de melhor às suas plantas!

pine bark

Everyone who loves gardening
knows the importance of giving
their plants the best there is to offer!

Cortezas de pinus

Quienes les encanta cuidar el jardín
conocen la importancia de darles
lo mejor a sus plantas!



casca de pinus polida

Polished Pine Bark
Corteza de Pino Pulida

<ul style="list-style-type: none"> • casca de pinus • 100% natural • pronto para uso 	<ul style="list-style-type: none"> • pine bark corteza de pino • 100% natural • ready for use lista para usar
---	--

REF.	TAMANHO APROXIMADO DA CASCA [cm]	PESO [KG]
91401/003	mini 1 a 2	0,3
91401/001		1
91401/005		5
91401/008		8
91402/003	P 2 a 3,5	0,3
91402/001		1
91402/005		5
91402/008		8
91403/003	M 3,5 a 7	0,3
91403/001		1
91403/005		5
91403/008		8
91404/001	G 7 a 15	1
91404/005		5
91404/008		8



casca de pinus triturada

Crushed Pine Bark
Corteza de Pino Triturada

<ul style="list-style-type: none"> • casca de pinus triturada • 100% natural • pronto para uso 	<ul style="list-style-type: none"> • crushed pine bark corteza de pino triturada • 100% natural • ready for use lista para usar
---	--

REF.	PESO [KG]
91400/010	1





substrato

Plant Substrate
Sustrato

- | | |
|--|---|
| <ul style="list-style-type: none"> • casca de pinus compostada • 100% natural • pronto para uso | <ul style="list-style-type: none"> • composted pine bark corteza de pino compostada • 100% natural • ready for use lista para usar |
|--|---|

REF.	PESO [KG]
91400/012	2
91400/011	10



mix para orquídea

Orchid Mix
Mmix para Orquídeas

- | | |
|---|--|
| <ul style="list-style-type: none"> • casca de pinus esterilizada e carvão vegetal • 100% natural • pronto para uso • ideal para orquídeas com raízes mais finas | <ul style="list-style-type: none"> • sterilized pine bark and charcoa • corteza de pino esterilizada y carbón vegetal • 100% natural • ready for use lista para usar • ideal for orchids with thinner roots • ideal para orquídeas con raíces más finas. |
|---|--|

REF.	TAMANHO APROXIMADO DA CASCA [cm]	PESO [KG]
91400/020	1 a 2	1



orquídea premium tipo exportação

Premium Export-type Orchid

Orquídea Premium Tipo Exportación

- | | |
|--|---|
| <ul style="list-style-type: none"> casca de pinus esterilizada e carvão vegetal 100% natural pronto para uso ideal para orquídeas com raízes mais robustas | <ul style="list-style-type: none"> sterilized pine bark and charcoa corteza de pino esterilizada y carbón vegetal 100% natural ready for use lista para usar ideal for orchids with stronger roots ideal para orquídeas con raíces más robustas |
|--|---|

REF.	TAMANHO APROXIMADO DA CASCA [cm]	PESO [KG]
91400/021	3 a 4	1
91400/025		5



substrato rosa do deserto

Pink Desert Rose Substrate

Sustrato Rosa del Desierto

- | | |
|---|---|
| <ul style="list-style-type: none"> casca de pinus compostada, casca de pinus triturada fina, carvão vegetal triturado e agrominerais 100% natural ideal para plantio de rosas do deserto | <ul style="list-style-type: none"> omposted pine bark, finely shredded pine bark, shredded charcoal and organic minerals corteza de pino compostada, corteza de pino triturada fina, carbón vegetal triturado y agrominerales 100% natural ideal for planting desert roses ideal para plantar rosas del desierto |
|---|---|

REF.	PESO [KG]
91400/030	1





SUPORTES PARA VASOS

Além de decorar, são muito práticos para acomodar os vasos, protegendo os móveis da umidade!
Com criatividade, podem ter diferentes usos!

support for vases

In addition to decorating, they are very convenient to hold plant pots, protecting the furniture against humidity!
With creativity, they can have different uses!

soporte para Macetas

¡Además de decorar, son muy prácticos para acomodar las macetas y proteger a los muebles contra la humedad!
¡Con creatividad, pueden tener diferentes usos!





suporte para vasos

Support for Vases

Soporte para Macetas

<ul style="list-style-type: none"> • pinus maciço • produto semi montado • acompanha parafuso para montagem • acabamento natural, sem pintura 	<ul style="list-style-type: none"> • solid pinus wood pino macizo • product sold semi-disassembled el producto se vende semi desmontado • hardware kit and assembly instructions enclosed viene con kit de herramientas e instrucciones de armado • natural unpainted wood finish terminación en madera natural, sin pintura
---	--

REF.	mm	COR COLOR COLOR
91620/610	C 594 x L 242 x A 210	natural



SUPORTA ATÉ
22kg



estante modulare

Modulare Shelving
Estanteria Modulare

• pinus maciço • solid pinus wood | pino macizo

REF.	PRATELEIRAS SHELVES ESTANTES	mm	COR COLOR COLOR
91622/016	2	L 622 x P 302 x A 432	natural
91621/002	2	L 900 x P 302 x A 432	
91620/017	3	L 622 x P 302 x A 752	
91621/003	3	L 900 x P 302 x A 752	
91620/019	4	L 622 x P 302 x A 1072	
91621/004	4	L 900 x P 302 x A 1072	
91620/018	5	L 622 x P 302 x A 1392	
91621/005	5	L 900 x P 302 x A 1392	
91620/020	6	L 622 x P 302 x A 1712	
91621/006	6	L 900 x P 302 x A 1712	

SUPORTA ATÉ

10kg

POR PRATELEIRA

É possível agrupar
outras unidades
de estantes.

It is possible to attach
other shelving units.

Se pueden agrupar otras
unidades de estanterías.

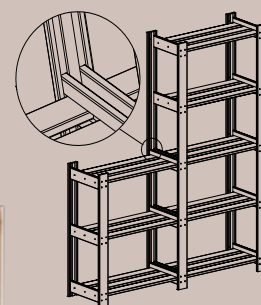
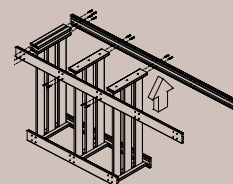
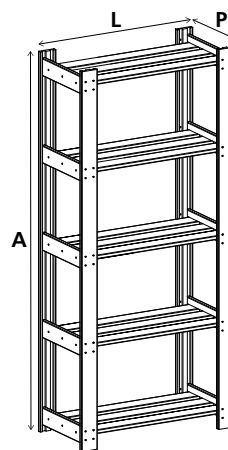



PAINÉIS EM MADEIRA MACIÇA

Personalize do seu jeito,
explore sua criatividade e
faça você mesmo.

Com Painés Tramontina,
você resolve seus problemas
e embeleza o ambiente da sua casa.

Painéis em diferentes estilos
de acabamento.

Disponíveis em várias dimensões.

Comprimentos de 60 a 200 cm
e larguras de 20 a 60 cm.

Espessura de 1,8 cm.

solid wood panels

Personalize them your way, let your
creativity flow and do it yourself.

With Tramontina's solid wood panels,
you will find solutions to your problems
and add beauty to your home.

paneles de madera maciza

Personalízalos a tu manera, explota
tu creatividad y hazlo tu mismo.

Con los paneles Tramontina,
resuelves tus problemas y embellezas
el ambiente de tu casa.

FAÇA VOCÊ MESMO | DIY | Hazia tu mismo



BANQUINHO stool | banquito

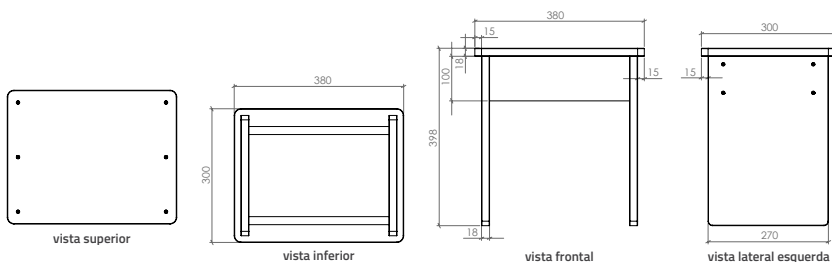

como fazer how to make it | cómo hacer

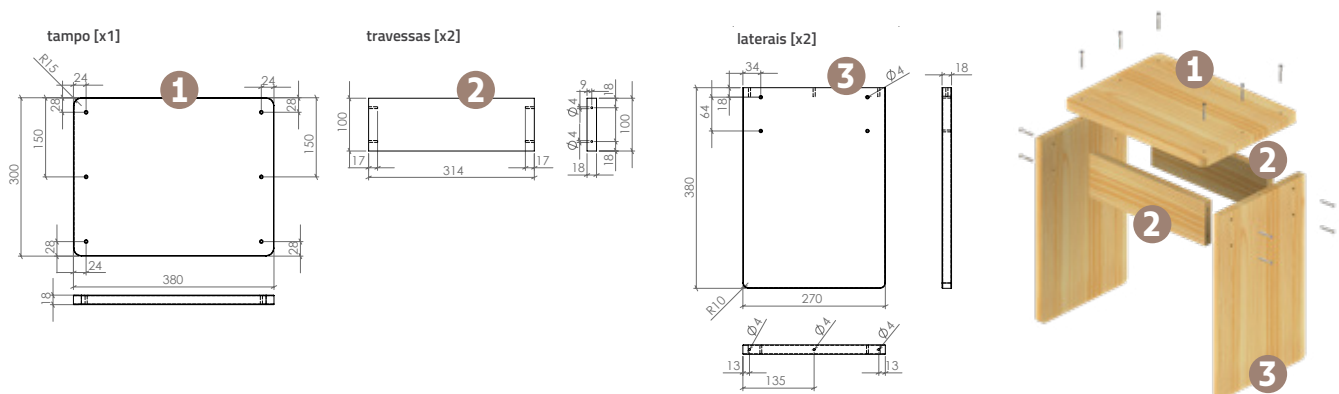

painéis necessários stool parts | paneles necesarios

2 painéis | panels | paneles **800 x 300 mm**



para fixar | to asseble | para fijar:
14 parafusos | screws | tornillos 4 x 35 mm



ESTANTE shelving | estanteria

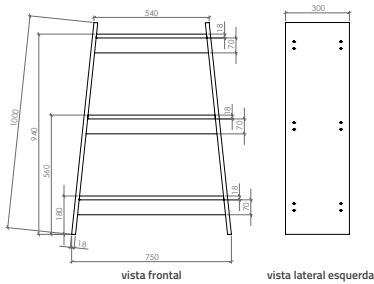

como fazer how to make it | cómo hacer

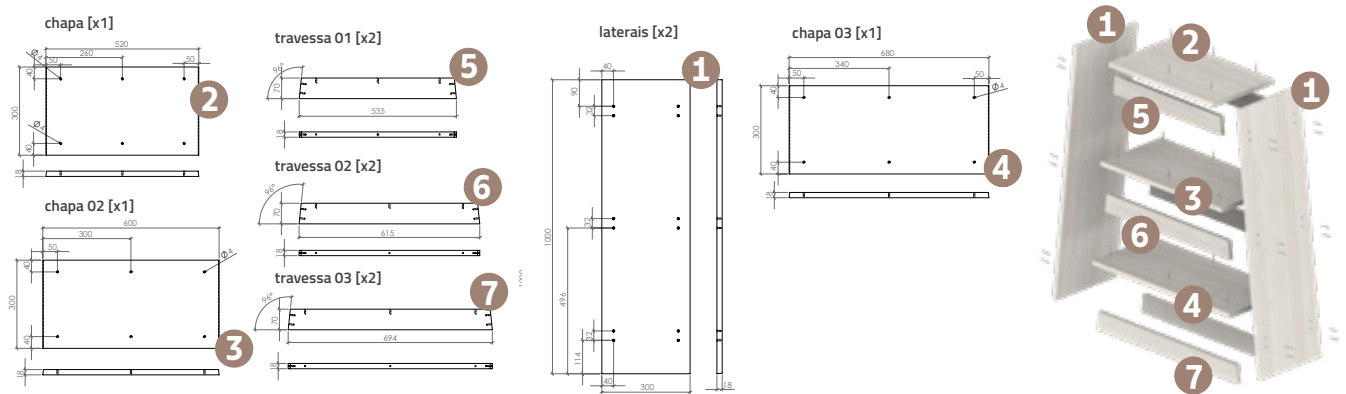

painéis necessários shelving parts | paneles necesarios

1 painel | panel | panel **800 x 300 mm**

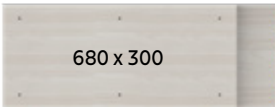

1 painéis | panels | paneles **600 x 300 mm**

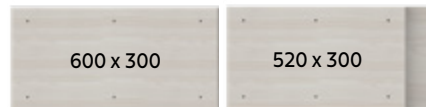

para fixar | to assemble | para fijar:
42 parafusos | screws | tornillos
4 x 35 mm

1 painel | panel | panel **1200 x 300 mm**

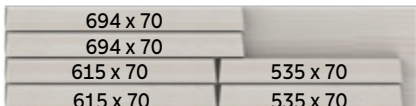

2 painéis | panels | paneles **1000 x 300 mm**



FAÇA VOCÊ MESMO | DIY | Hazia tu mismo



CAVALETE E ESTANTE trestles and shelf | caballete y estantería

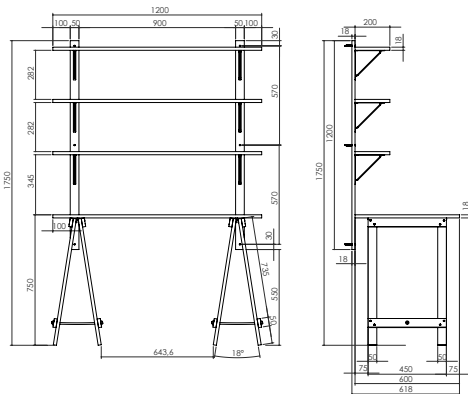

como fazer how to make it | cómo hacer

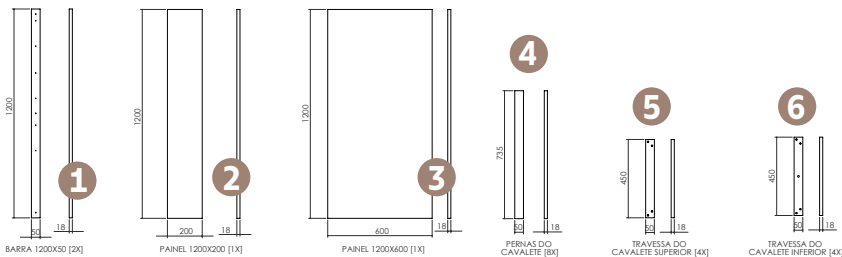

- 3 panels | 91150122 - 1200 x 200 mm [for shelves]
- 1 panel 91150126 - 1200 x 600 mm [for table top]
- 1 panel 91150126 - 1200 x 600 mm [for cutting the other necessary pieces]
- 6 brackets [91804010]
- 6 6mm fittings + 6 5x40 91800023 screws [to assemble the cross pieces to the wall]
- 48 3.5x16 screws [for the hinges and to assemble the shelves to the trestles]
- 32 3.5x30 screws + 4 hinges [for mounting the trestles]
- Rope to limit the opening of the trestle feet

painéis necessários trestles and shelf parts | paneles necesarios

- 3 painéis | 91150122 - 1200 x 200 mm [para prateleiras]
- 1 painel 91155128 - 1200 x 800 mm [para tampo da mesa]
- 1 painel 91155128 - 1200 x 800 mm [para o corte das demais peças necessárias]
- 6 suportes [91804010]
- 6 buchas 6mm + 6 parafusos 5x40 91800023 [para fixar as travessas na parede]
- 48 parafusos 3,5x16 (para as dobradiças e para fixar as prateleiras nos suportes)
- 32 parafusos 3,5x30 + 4 dobradiças [para montagem dos cavaletes]
- Cordea para limitar a abertura dos pés dos cavaletes

- 3 paneles | 91150122 - 1200 x 200 mm [para estantes]
- 1 panel | 91150126 - 1200 x 600 mm [para mesa]
- 1 panel 91150126 - 1200 x 600 mm [para el corte de las demás partes necesarias]
- 6 soportes [91804010]
- 6 tacos 6 mm + 6 tornillos 5 x 40 91800023 [para fijar los travesaños a la pared]
- 48 tornillos 3,5 x 16 [para las bisagras y para fijar los estantes a los soportes]
- 32 tornillos 3,5 x 30 + 4 bisagras [para armar los caballetes]
- Cuerda para limitar la abertura de las patas de los caballetes



CASINHA PET pet house | casa de mascota

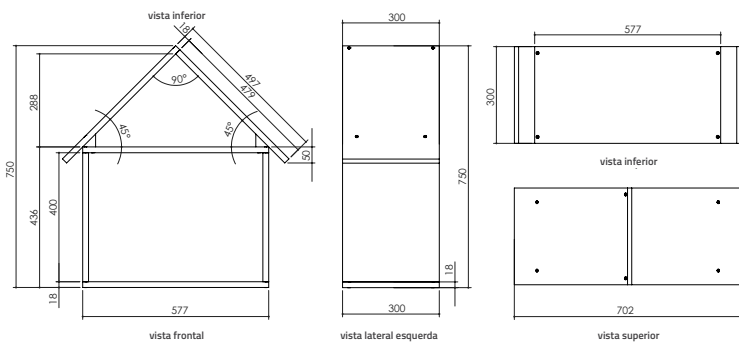

como fazer how to make it | cómo hacer

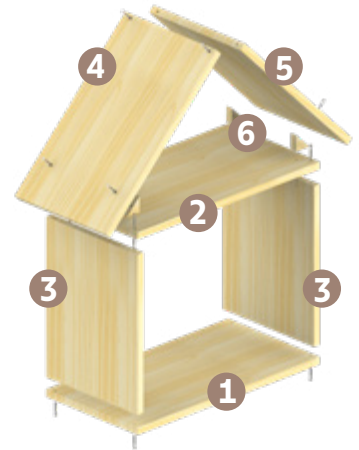
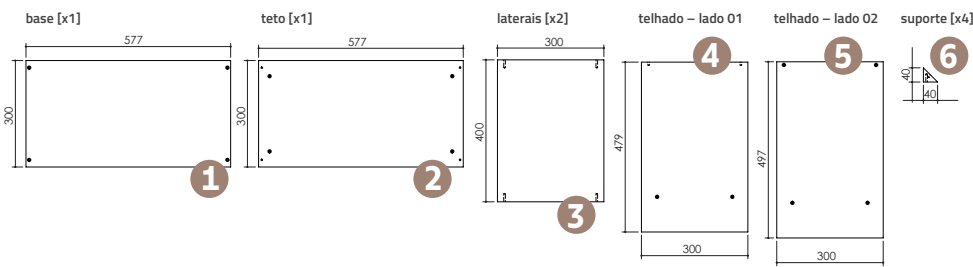

painéis necessários pet house parts | paneles necesarios

2 painéis | panels | paneles **1200 x 300 mm**



1 painéis | panels | paneles **1000 x 300 mm**



para fixar | to asseble | para fijar:
20 parafusos | screws | tornillos
4 x 35 mm

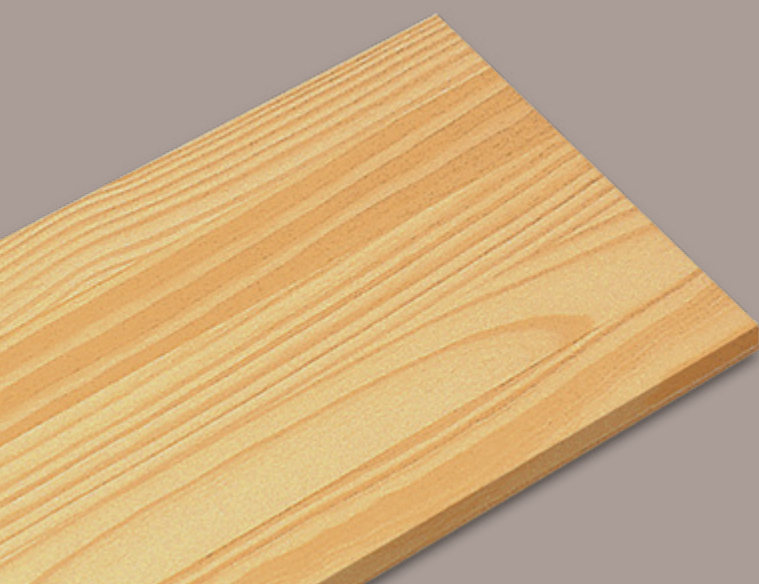

painel natural A/B

Natural A/B Panels
Paneles Natural A/B

REF.	mm			Esp.
	C	L	mm	
91122/062	600	200	18	
91122/063		300		
91122/082	800	200		
91122/083		300		
91122/102	1000	200		
91122/103		300		
91122/122	1200	200		
91122/123		300		

REF.	mm			Esp.
	C	L	mm	
91122/152	1500	200	18	
91122/153		300		
91122/154		400		
91122/202	2000	200		
91122/203		300		

painel natural C/C

Natural C/C Panels
Paneles Natural C/C

REF.	mm			Esp.
	C	L	mm	
91150/062	600	200	18	
91150/063		300		
91150/082	800	200		
91150/083		300		
91150/084	400			
91150/102	1000	200		
91150/103		300		
91150/104	400			
91150/122	1200	200		
91150/123		300		
91150/124		400		
91150/126		600		

REF.	mm			Esp.
	C	L	mm	
91150/152	1500	200	18	
91150/153		300		
91150/154		400		
91150/156	600			
91150/202	2000	200		
91150/203		300		
91150/206		600		

tampo para mesa C/C

REF.	mm			Esp.
	C	L	mm	
91155/128	1200	800	25	
91155/168	1600	800		

painel cor mel

Honey Color Panels
Paneles Color Miel

REF.	mm			Esp.
	C	L	mm	
91131/062	600	200	18	
91131/063		300		
91131/082	800	200		
91131/083		300		
91131/102	1000	200		
91131/103		300		
91131/122	1200	200		
91131/123		300		



painel cor branca

White Color Panels
Peneles Color Blanca

REF.	mm		
	C	L	Esp.
91133/062	600	200	18
91133/063		300	
91133/082	800	200	
91133/083		300	
91133/102	1000	200	
91133/103		300	
91133/122	1200	200	
91133/123		300	



painel cor tabaco

Tobacco Color Panels
Paneles Color Tabaco

REF.	mm		
	C	L	Esp.
91136/062	600	200	18
91136/063		300	
91136/082	800	200	
91136/083		300	
91136/102	1000	200	
91136/103		300	
91136/122	1200	200	
91136/123		300	

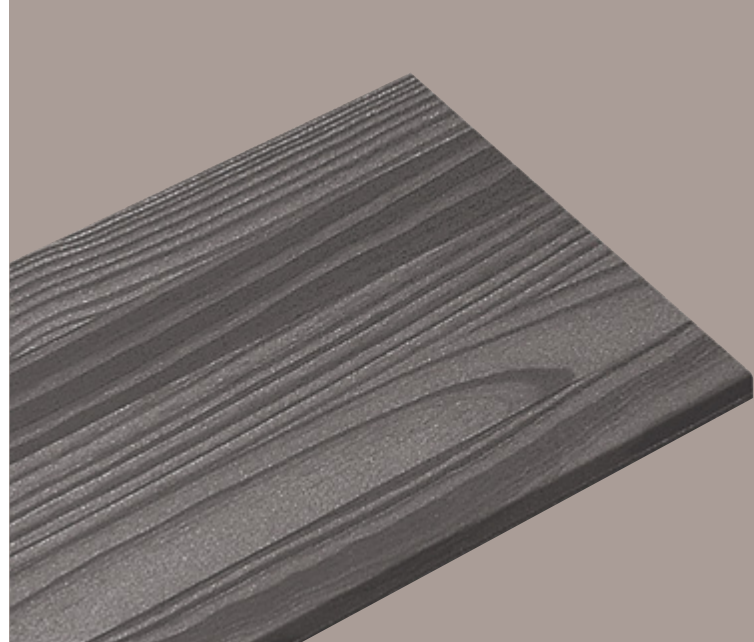

painel branco com borda

White Color Panels Edge
Paneles Color Blanco con Borde

REF.	mm		
	C	L	Esp.
91154/062	600	200	18
91154/063		300	
91154/064		400	
91154/082	800	200	
91154/083		300	
91154/084		400	
91154/102	1000	200	
91154/103		300	
91154/104		400	
91154/122	1200	200	
91154/123		300	
91154/124		400	
91154/126		600	

REF.	mm		
	C	L	Esp.
91154/152	1500	200	18
91154/153		300	
91154/154		400	
91154/156	2000	600	
91154/202		200	
91154/203		300	
91154/206		600	



suporte premium mão francesa

French Hand Premium Bracket
Soporte Premium Mano Francês

• em aço	• in steel en acero
----------	-----------------------

REF.	mm	COR COLOR COLOR
91804/010	A 170 x P 170 x L 14	branca white blanca
91804/011	A 200 x P 200 x L 14	



SUPORTA ATÉ
5kg

suporte premium plus mão francesa

French Hand Premium Plus Bracket
Soporte Premium Plus Mano Francês

• em aço	• in steel en acero
----------	-----------------------

REF.	mm	COR COLOR COLOR
91804/030	A 155 x P 275 x L 19	branca white blanca
91804/040	A 200 x P 350 x L 19	



SUPORTA ATÉ
12,5kg

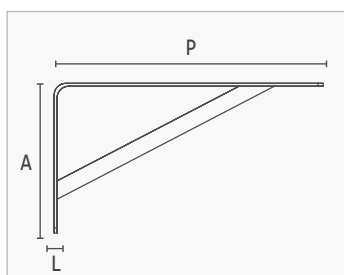

suporte curvo

Curved Bracket
Soporte Curvo

• em aço	• in steel en acero
----------	-----------------------

REF.	mm	COR COLOR COLOR
91804/001	A 100 x P 146 x L 37	branca white blanca
91804/002	A 153 x P 200 x L 37	
91804/003	A 204 x P 249 x L 37	
91804/004	A 254 x P 304 x L 37	
91809/001	A 100 x P 146 x L 37	preta black negra
91809/002	A 153 x P 200 x L 37	
91809/003	A 204 x P 249 x L 37	
91809/004	A 254 x P 304 x L 37	



SUPORTA ATÉ
5kg

suporte metálico

Metallic Bracket
Soporte Metálico

• em aço	• in steel en acero
----------	-----------------------

REF.	mm	COR COLOR COLOR
91289/009	A 200 x P 200 x L 19	preta black negra
91284/009	A 200 x P 200 x L 19	branca white blanca



SUPORTA ATÉ
5kg

Kit de Ferragens

Screw Kit with Nylon Bushings
Kit de Tornillos con Casquillos de Nylon

• Parafusos cabeça "Philips"

REF.	mm	COR COLOR COLOR
91800/022	02 parafusos cabeça chata fenda cruzada 4x50mm. 02 buchas de nylon 6mm 03 parafusos cabeça chata fenda cruzada 3,5x16mm	
91800/023	03 parafusos cabeça chata fenda cruzada 4x50mm. 03 buchas de nylon 6mm 03 parafusos cabeça chata fenda cruzada 3,5x16mm	



OTIMIZANDO A ÁREA DE SERVIÇO

optimizing your utility room | optimizando el área de servicio







VARAIS TRAMONTINA

Secou, dobrou, guardou.
Indispensáveis em qualquer
lavanderia ou área de serviço.

Tramontina clothes

Dry, fold, store.

Indispensable for any utility room.

tendederos Tramontina

Se secó, se plegó, se guardó.

Indispensables en cualquier lavandería
o área de servicio.



varal premium

Premium Drying Rack
Tendedero Premium

- | | |
|---|---|
| <ul style="list-style-type: none"> • estrutura em aço inox • pés antiderrapantes • ponteiros em plástico | <ul style="list-style-type: none"> • stainless steel structure • estructura en acero inox • non-skid feet patas antideslizantes • plastic tips punteras em plástico |
|---|---|

REF.	mm	SUPOSTA COLOR COLOR	SECA COLOR COLOR
91854/200	C 1460 x L 600 x A 955	14 kg	15 m

aço inox

stainless steel
acero inox

Capacidade
máxima de
secagem:
15 metros



varal com abas

Drying Rack with Wings
Tendedero con Aletas

- | | |
|--|---|
| <ul style="list-style-type: none"> • estrutura em aço • pintura eletrostática • anel de travamento • pés antiderrapantes | <ul style="list-style-type: none"> • structure in steel estructura en acero • power coating pintura en polvo • locking ring anillo de traba • non-skid feet patas antideslizantes |
|--|---|

REF.	mm	SUPOSTA COLOR COLOR	SECA COLOR COLOR
91854/150	C 1500 x L 500 x A 873	9 kg	12 m
91854/182	C 1820 x L 500 x A 1000	9 kg	15 m

Capacidade
máx. de secagem:
12 metros
91854/150
15 metros
91854/182



CAIXA EXPOSITORA

varal sem abas

Drying Rack without Wings
Tendedero sin Aletas

- | | |
|--|---|
| <ul style="list-style-type: none"> • estrutura em aço • pintura eletrostática • anel de travamento • pés antiderrapantes | <ul style="list-style-type: none"> • structure in steel estructura en acero • power coating pintura en polvo • locking ring anillo de traba • non-skid feet patas antideslizantes |
|--|---|

REF.	mm	SUPOSTA COLOR COLOR	SECA COLOR COLOR
91854/105	C 900 x L 500 x A 790	4 kg	7 m

Capacidade
máxima de
secagem:
7 metros



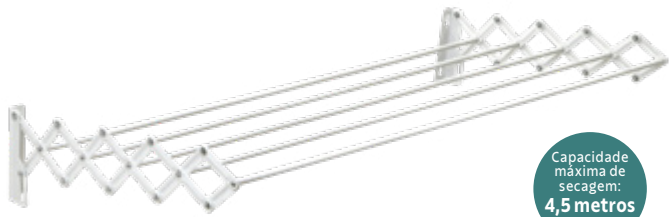

Capacidade máxima de secagem:
4,5 metros
5 kg

varal sanfonado

Drying Rack
Tendedero Extensible

• estrutura em aço	• steel structure estructura en acero
• pintura epoxy	• epoxy finish terminación epoxi

REF.	mm	SUPORTA COLOR COLOR	SECA COLOR COLOR
91874/090	C 908 x L 400 x A 120	5 kg	4.5 m



Capacidade máxima de secagem:
5,4 metros
9 kg

varal de teto

Ceiling Mounted Drying Rack
Tendedero de Techo

• estrutura em aço	• steel structure estructura en acero
• pintura eletrostática	• power coating pintura en polvo

REF.	mm	SUPORTA COLOR COLOR	SECA COLOR COLOR
91864/090	C 900 x L 550 x A 16	9 kg	5.4 m



varal umbrella alumínio

Umbrella aluminum Dry Rack
Tendedero Umbrella alumínio

- | | |
|---|--|
| <ul style="list-style-type: none"> • estrutura em alumínio • mecanismo de elevação e trava • dobrável, fácil de armazenar, montar e movimentar | <ul style="list-style-type: none"> • structure in aluminum • lifting and locking mechanism • folding, easy to store, to set up and move |
|---|--|

REF.	mm	SUPORTA COLOR COLOR	SECA COLOR COLOR
91854/193	C 1930 x L 1930 x A 1800	50 kg	50 m



varal vertical

Vertical Drying Rack
Tendedero Vertical

- | | |
|---|---|
| <ul style="list-style-type: none"> • estrutura em aço inox • prateleiras dobráveis • produto resistente a ferrugem | <ul style="list-style-type: none"> • stainless steel structure • estrutura en acero inoxidable • fold-up tiers estantes plegables • material that is resistant to corrosion • producto resistente al herrumbre |
|---|---|

REF.	mm	SUPORTA COLOR COLOR	SECA COLOR COLOR
91854/170	C 750 x L 640 x A 1700	26 kg	17 m





MESAS DE PASSAR

Leveza e praticidade.
Dobráveis e com suporte
para ferro de passar.
Várias cores e acabamentos
para fazer bonito na área de serviço.

ironing boards

Lightness and convenience.
Foldable with iron holder.
Available in various colors and options of finishes
for doing what you do beautifully in your utility room.

mesas de planchar

Livianas y prácticas.
Plegables y con soporte para la plancha.
Varios colores y terminaciones para lucirse
en el área de servicio.



mesa de passar premium

Premium Ironing Board
Mesa de Planchar Premium

<ul style="list-style-type: none"> tampo em tela expandida estrutura em aço acabamento epóxi branco dobrável, com regulagem de altura e trava de segurança suporte para roupas e ferro de passar 	<ul style="list-style-type: none"> cover in stretchable estructura en malla expandida structure in steel estructura en acero with white epoxy finish terminación epoxi blanca foldable, with height adjustment and safety lock plegable, regulado de altura y traba seguridad garment shelf and iron rest soporte para ropa y plancha
---	--

REF.	mm	COR COLOR COLOR
91754/200	L 1194 x P 355 x A 900	branca white blanca

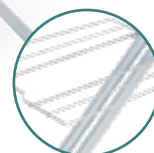

SUPORTE PARA A ROUPA E PARA O FERRO

mesa de passar top

Top Ironing Board
Mesa de Planchar Top

<ul style="list-style-type: none"> estrutura em pinus maciço articulações e suporte em metal para ferro de passar 	<ul style="list-style-type: none"> structure in solid pinus wood estructura en pino macizo metallic joints and brackets for iron articulaciones y soportes en metal para plancha
---	--

REF.	mm	COR COLOR COLOR
91751/123	L 1420 x P 395 x A 880	mel honey miel
91750/009		revestimento térmico thermal coating revestimiento térmico

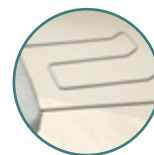

SUPORTE PARA O FERRO

mesa de passar compact classic

Compact Ironing Board
Mesa de Planchar Compact

<ul style="list-style-type: none"> estrutura em pinus maciço suporte em metal para ferro de passar 	<ul style="list-style-type: none"> structure in solid pinus wood estructura en pino macizo metal brackets for iron soportes en metal para planchar
--	--

REF.	mm	COR COLOR COLOR
91750/130	L 1160 x P 340 x A 840	natural compact
91750/140		natural classic
91750/010		revestimento



SUPORTE PARA O FERRO





mesa de passar - apoio

Tabletop Ironing Board
Mesa de Planchar de Apoio

- estrutura em madeira maciça
- pé em aço
- structure in solid wood
- estrutura en madera maciza
- feet in steel | pies en acero

REF.	mm	COR COLOR COLOR
91750/135	L 852 x P 252 x A 137	cinza gray gris



mesa de passar - dobrável

Foldable Tabletop Ironing Board
Mesa de Planchar Plegable

- estrutura em madeira maciça
- pé em aço
- structure in solid wood
- estrutura en madera maciza
- feet in steel | pies en acero

REF.	mm	COR COLOR COLOR
91750/136	L 852 x P 252 x A 140	cinza gray gris



cesto organizador com corda

Organizer Basket with Fastener Closure
Cesta Organizadora con Cierre

- lona 100% algodão
- corda para fechamento
- 100% cotton canvas | lona 100% algodón
- ropes for closing | cuerdas para cierre

REF.	mm	COR COLOR COLOR
91751/001	L 350 x P 350 x A 430	natural
91751/002		cinza gray gris

CAPACIDADE

41L



cesto organizador com fecho

Organizer Basket with Fastener Closure
Cesta Organizadora con Cierre

- lona 100% algodão
- tampa com fecho
- 100% cotton canvas | lona 100% algodón
- lid with closure | tapa con cierre

REF.	mm	COR COLOR COLOR
91751/006	L 350 x P 350 x A 430	natural
91751/007		cinza gray gris

CAPACIDADE

41L





cesto multiuso

Multi-Purpose Basket
Cesto Multiuso

- | | |
|-------------------------------|--|
| • estrutura em madeira maciça | • structure in solid wood |
| • tecido 100% algodão | • estrutura en madera maciza |
| • capacidade: 42 litros | • 100% cotton 100% algodón |
| | • capacity: 42 liters capacidad: 42 litros |

REF.	mm	COR COLOR COLOR
91757/250	L 405 x P 398 x A 630	bege beige beige
91757/251		cinza gray gris



organizador de parede

Wall Organizer
Organizador de Pared

- | | |
|----------------------|--|
| • suporte de madeira | • wood block soporte de madera |
| • lona 100% algodão | • 100% cotton canvas lona 100% algodón |

REF.	mm	COR COLOR COLOR
91751/011	L 300 x P 158 x A 248	natural
91751/012		cinza gray gris



SUPORTA ATÉ

5kg

organizador de parede - 2 bolsos

Wall Organizer - 2 pockets

Organizador de Pared - 2 bolsillos

• corda para pendurar	• rope for hanging cuerda para colgar
• lona 100% algodão	• 100% cotton canvas lona 100% algodón

REF.	mm	COR COLOR COLOR
91751/021	L 550 x P 240 x A 80	natural
91751/022		natural-cinza natural-gray natural-gris
91751/023		cinza gray gris
91751/024		cinza-ntaural gray-natural gris-ntaural



SUPORTA ATÉ
2kg

POR BOLSO



organizador de parede - 3 bolsos

Wall Organizer - 3 pockets

Organizador de Pared - 3 bolsillos

• corda para pendurar	• rope for hanging cuerda para colgar
• lona 100% algodão	• 100% cotton canvas lona 100% algodón

REF.	mm	COR COLOR COLOR
91751/031	L 790 x P 240 x A 80	natural
91751/032		natural-cinza natural-gray natural-gris
91751/033		cinza gray gris
91751/034		cinza-ntaural gray-natural gris-ntaural



SUPORTA ATÉ
2kg

POR BOLSO



expositores

Display Expositores

- | | |
|--|--|
| <ul style="list-style-type: none"> em pinus maciço pintado acessórios para colocação dos outros produtos | <ul style="list-style-type: none"> painted solid pinus wood en pino maciço pintado accessories for rank of the products accesorios para disponer los productos |
|--|--|

REF.	mm
91221/016	L 906 x P 668 x A 1500
91221/017	L 906 x P 668 x A 1500
91960/001	L 650 x P 550 x A 1500
91961/001	L 1140 x P 590 x A 560

91960/001



91221/016



91221/017





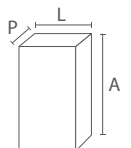















91961/001









informações para logística

information for logistics | informaciones para logística

	REF.	COR COLOR COLOR	EAN 78.977.462	EMB. PKG. EMB.					
				cm					
				UN.	KG	M ³	L	P	A
	91854/200	branca white blanca	0727 4	6	18,40	0,281	108	62	42
	91854/105	branca white blanca	8770 2	6	9,76	0,089	113	56	14
	91854/150	branca white blanca	8771 9	6	16,00	0,109	112	57	17
	91854/182		8772 6	6	18,20	0,121	125	57	17
	91874/090	branca white blanca	6664 6	6	7,80	0,084	93,5	32	28
	91864/090	branca white Blanca	6665 3	6	7,70	0,063	92	57	12
	91854/193	branca white blanca	3367 9	1	3,65	0,058	245	15,5	15,5
	91854/170	branca white blanca	9344 4	1	5,60	0,076	80	35,5	27
	91754/200	branca white blanca	0728 1	24	157,80	1,035	155	75	89
	91751/123	mel honey miel	0223 1	30	236	1,383	131	116	91
	91750/009	cinza gray gris	0243 9	12	1,30	0,012	26	23	20
	91750/130	natural	0513 3	30	165,00	1,013	122	100	83
	91750/140								
	91750/135	cinza gray gris	6670 7	6	13,481	0,052	90,9	26,5	21,6
	91750/136	cinza gray gris	6671 4	6	16,063	0,035	86,4	27	15
	91757/250	bege beige beige	6667 7	5	9,915	0,096	74,2	41,4	31,3
	91757/251	cinza gray gris	6669 1						
	91751/001	natural	1319 0	6	2,67	0,0297	44,5	15	44,5
	91751/002	cinza gray gris	1320 6						
	91751/006	natural	1321 3	6	2,67	0,0097	44,5	15	44,5
	91751/007	cinza gray gris	1322 0						
	91751/011	natural	1323 7	6	1,77	0,0097	26	10	37,5
	91751/012	cinza gray gris	1324 4						
	91751/021	natural	1329 9	6	1,28	0,0103	35	9,5	31
	91751/022	natural-cinza natural-gray	1330 5						
	91751/023	cinza gray gris	1332 9						
	91751/024	cinza-natural gray-natural	1333 6						
	91751/031	natural	1325 1	6	1,63	0,0103	35	9,5	31
	91751/032	natural-cinza natural-gray	1326 8						
	91751/033	cinza gray gris	1327 5						
	91751/034	cinza-natural gray-natural	1328 2						





	REF.	COR COLOR COLOR	EAN 78.977.462	EMB. PKG. EMB.					
				cm					
				UN.	KG	M ³	L	P	A
	91410/072	natural	0877 6	1	4,6	0,030	70,5	41	10,5
	91411/072	amarela yellow amarilla	0720 5						
	91411/172	amarela yellow amarilla	8006 2						
	91412/072	azul blue azul	0722 9						
	91412/172	azul blue azul	8007 9						
	91413/072	vermelha red roja	0724 3						
	91413/172	vermelha red roja	8008 6						
	91414/072	branca white blanca	9928 6						
	91414/172	branca white blanca	8009 3						
	91417/072	verniz varnished barniz	9926 2						
91418/072	preta black negra	0562 1							
91418/172	preta black negra	8010 9							
91417/078	preto e verniz black and varnisher	6364 5							
91417/178	GARAPA	6878 7							
	91410/047	natural	0876 9	1	3,73	0,016	45	34	10,5
	91411/047	amarela yellow amarilla	0719 9						
	91411/147	amarela yellow amarilla	8001 7						
	91412/047	azul blue azul	0721 2						
	91412/147	azul blue azul	8002 4						
	91413/047	vermelha red roja	0723 6						
	91413/147	vermelha red roja	8003 1						
	91414/047	branca white blanca	9927 9						
	91414/147	branca white blanca	8004 8						
	91417/047	verniz varnished barniz	9925 5						
91418/047	preta black negra	0563 8							
91418/147	preta black negra	8005 5							
91417/048	preto e verniz black and varnisher	6363 8							
91417/148	GARAPA	6877 0							
	91442/072	cinza gray gris	6369 0	1	4,6	0,030	70,5	41	10,5
	91444/072	branca white blanca	6370 6						
	91448/072	preta black negra	6371 3						
	91449/072	camurça suede gamuza	6375 1						
	91442/047	cinza gray gris	6365 2	1	3,73	0,016	45	34	10,5
	91444/047	branca white blanca	6366 9						
	91448/047	preta black negra	6367 6						
	91449/047	camurça suede gamuza	6368 3						
	91390/002	coral	1314 5	10	8,66	0,059	48	28	43
			120	118,00	0,893	114	98	80	
	91390/003	camurça suede gamuza	1315 2	10	8,66	0,059	48	28	43
			120	118,00	0,893	114	98	80	
	91390/004	branca white blanca	1316 9	10	8,66	0,059	48	28	43
			120	118,00	0,893	114	98	80	
	91390/008	preta black negra	1317 6	10	8,66	0,059	48	28	43
			120	118,00	0,893	114	98	80	
91390/108	preta black negra	0514 0	10	8,66	0,060	48	29	43	
		120	118,00	0,894	114	98	80		
91394/108	branca white blanca	0523 2	10	8,66	0,060	48	29	43	
		120	118,00	0,894	114	98	80		
91390/119	grafite graphite grafito	6376 8	10	8,66	0,060	48	29	43	
		120	118,00	0,894	114	98	80		

	REF.	COR COLOR COLOR	EAN 78.977.462	EMB. PKG. EMB.					
				cm					
				UN.	KG	M ³	L	P	A
	91756/101		7277 7	1	55	0,3486	200	84	10,5
	91756/023	garapa	4243 5	1	13,5	0,0882	200	32	10,5
	91756/028		7243 2	1	22	0,1722	200	82	10,5
	91750/100	natural	9931 6						
	91754/100	branca white blanca	9944 6	1	49,60	0,224	200,5	81	18
	91757/100	verniz varnished barniz	0015 2						
	91750/103	natural	0666 1	1	40,85	0,189	132	82	21,8
	91750/018	natural	0075 1	1	22,73	0,117	132	82	10,8
	91750/013	natural	0075 0	1	9,06	0,036	1115	29,5	11
	91750/028	natural	9930 9						
	91754/028	branca white blanca	0018 3	1	26,40	0,114	200,5	81	7
	91757/028	verniz varnished barniz	0019 0						
	91750/023	natural	9929 3						
	91754/023	branca white blanca	0016 9	1	11,60	0,065	201	29,5	11
	91757/023	verniz varnished barniz	0017 6						
	91750/073	natural	7799 4						
	91751/073	amarela yellow amarilla	6327 0						
	91752/073	azul blue azul	6300 3	1	11,33	0,027	75	42	8,5
	91753/073	vermelha red roja	6301 0						
	91754/073	branca white blanca	7799 4						
	91734/074	branca white blanca	0601 7	1	3,86	0,009	82	45,5	2,5
	91620/610	natural	1410 4	3	5,89	0,0219	56,2	24,6	15,9
	91470/060	natural	1411 1	10					
	91474/060	branco white blanco	1412 8	10					
	91477/060	verniz varnished barniz	1413 5	10	0,45	0,0015	22,3	10,8	6,5
	91478/060	preto black negro	1414 2	10					
	91470/120	natural	1415 9	10					
	91474/120	branco white blanco	1416 6	10	1,25	0,0046	22,3	16,8	12,5
	91477/120	verniz varnished barniz	1417 3	10					
	91478/120	preto black negro	1418 0	10					

	REF.	COR COLOR COLOR	EAN 78.977.462	EMB. PKG. EMB.					
				cm					
				UN.	KG	M ³	L	P	A
	91220/410		0828 8	6	5,10	0,008	42	11,5	16
	91220/415		0831 1	6	7,80	0,011	42	16,5	16
	91220/420		0832 5	6	10,20	0,014	42	21,5	16
	91220/510		0834 9	6	6,50	0,010	52	11,5	16
	91220/515	transparente	0835 6	6	9,50	0,014	52	16,5	16
	91220/520		0836 3	6	12,50	0,018	52	21,5	16
	91220/610		6700 1	6	7,15	0,011	62	11,5	16
	91220/615		6701 8	6	10,85	0,016	62	16,5	16
	91220/620		6702 5	6	13,89	0,021	62	21,5	16
	91220/002		0823 3	1	4,13	0,008	22	23	16
	91220/025	transparente	0837 0	6	6,30	0,010	27,5	28	12,5
	91220/003		0824 0	6	8,80	0,013	32	33	12
	91221/002		0825 7	6	4,13	0,008	22	23	16
	91221/025	transparente	0839 4	6	6,30	0,010	27,5	28	12,5
	91221/003		0827 1	6	8,80	0,013	32	33	12
	91774/002	branca white blanca	0604 8	1	2,50	0,005	28,5	22,5	8
	91776/002	tabaco tobacco tabaco	0605 5						
	91774/003	branca white blanca	0607 9	1	2,66	0,006	32,5	22,5	8
	91776/003	tabaco tobacco tabaco	0608 6						
	91284/645	branca white blanca	6634 9	5	15,87	0,0297	61,5	46	10,5
	91283/067		0972 8	5	8,33	0,015	64	26	9
	91283/097	maple	0975 9	5	11,16	0,022	94	26	9
	91283/127		0978 0	5	14,66	0,029	124	26	9
	91286/067		0973 5	5	8,33	0,015	64	26	9
	91286/097	tabaco tobacco tabaco	0976 6	5	11,16	0,022	94	26	9
	91286/127		0979 7	5	14,66	0,029	124	26	9
	91287/067		0974 2	5	8,33	0,015	64	26	9
	91287/097	noce brianza	0977 3	5	11,16	0,022	94	26	9
	91287/127		0980 3	5	14,66	0,029	124	26	9
	91284/067		7774 1	5	8,33	0,015	64	26	9
	91284/097	branca white blanca	7773 4	5	11,16	0,022	94	26	9
	91284/127		7772 7	5	14,66	0,029	124	26	9
	91285/067		9812 8	5	8,33	0,015	64	26	9
	91285/097	amêndoa almond almendra	9813 5	5	11,16	0,022	94	26	9
	91285/127		9814 2	5	14,66	0,029	124	26	9
	91283/041		6600 4	6	7,33	0,017	41	26	16
	91283/061		6270 9	6	8,33	0,025	61	26	16
	91283/091	maple	6271 6	6	12,70	0,038	91	26	16
	91283/121		6272 3	6	15,33	0,050	121	26	16
	91286/041		6603 5	6	7,33	0,017	41	26	16
	91286/061		6270 9	6	8,33	0,025	61	26	16
	91286/091	tabaco tobacco tabaco	0976 6	6	12,70	0,038	91	26	16
	91286/121		0979 7	6	15,33	0,050	121	26	16
	91287/041		6604 2	6	7,33	0,017	41	26	16
	91287/061		0974 2	6	8,33	0,025	61	26	16
	91287/091	noce brianza	0977 3	6	12,70	0,038	91	26	16
	91287/121		0980 3	6	15,33	0,050	121	26	16
	91284/041		6601 1	6	7,33	0,017	41	26	16
	91284/061	branca white blanca	7774 1	6	8,33	0,025	61	26	16
	91284/091		7773 4	6	12,70	0,038	91	26	16
	91284/121		7772 7	6	15,33	0,050	121	26	16
	91285/041	amêndoa almond almendra	6602 8	6	7,33	0,017	41	26	16
	91285/061		9812 8	6	8,33	0,025	61	26	16

informações para logística

information for logistics | informaciones para logística

	REF.	COR COLOR COLOR	EAN 78.977.462	EMB. PKG. EMB.					
				cm					
				UN.	KG	M ³	L	P	A
	91285/091	amêndoa almond almendra	9813 5	6	12,70	0,038	91	26	16
	91285/121		9814 2	6	15,33	0,050	121	26	16
	91273/065	maple	0981 0	3	6,83	0,019	61	26,5	12
	91273/095		0984 1	3	8,36	0,029	91	26,5	12
	91273/125		0987 2	3	12,76	0,038	121	26,5	12
	91286/065	tabaco tobacco tabaco	0982 7	3	6,83	0,019	61	26,5	12
	91286/095		0985 8	3	8,36	0,029	91	26,5	12
	91286/125		0988 9	3	12,76	0,038	121	26,5	12
	91287/065	noce brianza	0983 4	3	6,83	0,019	61	26,5	12
	91287/095		0986 5	3	8,36	0,029	91	26,5	12
	91287/125		0989 6	3	12,76	0,038	121	26,5	12
	91284/065	branca white blanca	7777 2	3	6,83	0,019	61	26,5	12
91284/095	7775 8		3	8,36	0,029	91	26,5	12	
91284/125	7776 5		3	12,76	0,038	121	26,5	12	
91285/065	amêndoa almond almendra	0564 5	3	6,83	0,019	61	26,5	12	
91285/095		0754 0	3	8,36	0,029	91	26,5	12	
91285/125		9811 1	3	12,76	0,038	121	26,5	12	
	91240/052	natural	0130 2	10	10,73	0,028	51	20	27
	91244/052	branca white blanca	1302 2	10	10,73	0,028	51	20	27
	91246/052	tabaco tobacco tabaco	1303 9	10	10,73	0,028	51	20	27
	91200/002	natural	0005 3	6	2,50	0,007	24,5	21	13
	91200/003		0006 0	6	5,15	0,014	34,5	31	13
	91200/004		0007 7	6	8,33	0,024	44,5	41	13
	91201/002	mel honey miel	0068 8	6	2,50	0,007	24,5	21	13
	91201/003		0069 5	6	5,15	0,014	34,5	31	13
	91201/004		0070 1	6	8,33	0,024	44,5	41	13
	91204/002	branca white blanca	0103 6	6	2,50	0,007	24,5	21	13
	91204/003		0104 3	6	5,15	0,014	34,5	31	13
	91204/004		0105 0	6	8,33	0,024	44,5	41	13
	91206/002	tabaco tobacco tabaco	0321 4	6	2,50	0,007	24,5	21	13
	91206/003		0322 1	6	5,15	0,014	34,5	31	13
	91206/004		0323 8	6	8,33	0,024	44,5	41	13
	91240/042	natural	0359 7	6	6,16	0,016	41	21	18,5
	91240/062		0008 4	6	9,16	0,024	61	21	18,5
	91240/092		0009 1	6	12,00	0,035	91	21	18,5
	91240/112	0350 4	6	16,00	0,047	121	21	18,5	
	91241/042	mel honey miel	0360 3	6	6,16	0,016	41	21	18,5
	91241/062		0074 9	6	9,16	0,024	61	21	18,5
	91241/092		0075 6	6	12,00	0,035	91	21	18,5
	91241/112	0076 3	6	16,00	0,047	121	21	18,5	
	91244/042	branca white blanca	0362 7	6	6,16	0,016	41	21	18,5
	91244/062		0106 7	6	9,16	0,024	61	21	18,5
	91244/092		0107 4	6	12,00	0,035	91	21	18,5
	91244/122	0108 1	6	16,00	0,047	121	21	18,5	
91246/042	tabaco tobacco tabaco	0363 4	6	6,16	0,016	41	21	18,5	
91246/062		0251 4	6	9,16	0,024	61	21	18,5	
91246/092		0252 1	6	12,00	0,035	91	21	18,5	
91246/112	0253 8	6	16,00	0,047	121	21	18,5		
91249/042	berinjela eggplant berenjena	2051 8	6	6,16	0,016	41	21	18,5	
91249/062		2052 5	6	9,16	0,024	61	21	18,5	
91249/092		2053 2	6	12,00	0,035	91	21	18,5	
91249/112		2054 9	6	16,00	0,047	121	21	18,5	

	REF.	COR COLOR COLOR	EAN 78.977.462	EMB. PKG. EMB.					
				cm					
				UN.	KG	M ³	L	P	A
	91150/062	natural C/C	2028 0	5	6,28	0,012	61	21	9,5
	91150/063		2029 7	5	9,18	0,018	61	31	9,5
	91150/082		2030 3	5	8,28	0,016	61	21	9,5
	91150/083		2048 8	5	12,13	0,024	81	31	9,5
	91150/084		2031 0	5	15,97	0,032	81	41	9,5
	91150/102		2032 7	5	10,27	0,02	101	21	9,5
	91150/103		2049 5	5	15,07	0,03	101	31	9,5
	91150/104		2033 4	5	19,87	0,039	101	41	9,5
	91150/122		2034 1	5	12,27	0,024	121	21	9,5
	91150/123		2035 8	5	18,02	0,036	121	31	9,5
	91150/124		2036 5	5	23,77	0,047	121	41	9,5
	91150/126		2037 2	5	35,26	0,07	121	61	9,5
91150/152	2038 9	5	15,26	0,03	151	21	9,5		
91150/153	2039 6	5	22,43	0,044	151	31	9,5		
91150/154	2040 2	5	29,61	0,059	151	41	9,5		
91150/156	2041 9	5	43,95	0,088	151	61	9,5		
91150/202	2050 1	5	20,25	0,04	201	21	9,5		
91150/203	2042 6	5	29,8	0,059	201	31	9,5		
91150/206	2043 3	5	58,44	0,116	201	61	9,5		
91155/128	1312 1	1	12	0,024	121	81	2,2		
91155/168	1313 8	1	16	0,032	161	81	2,2		
91131/062	0268 2	5	6,28	0,012	61	21	9,5		
91131/063	0269 9	5	9,18	0,018	61	31	9,5		
91131/082	0270 5	5	8,28	0,016	81	21	9,5		
91131/083	0271 2	5	12,13	0,024	81	31	9,5		
91131/102	0272 9	5	10,27	0,02	101	21	9,5		
91131/103	0273 6	5	15,07	0,03	101	31	9,5		
91131/122	0274 3	5	12,27	0,024	121	21	9,5		
91131/123	0275 0	5	18,02	0,036	121	31	9,5		
91133/062	0281 1	5	6,28	0,012	61	21	9,5		
91133/063	0282 8	5	9,18	0,018	61	31	9,5		
91133/082	0283 5	5	8,28	0,016	81	21	9,5		
91133/083	0284 2	5	12,13	0,024	81	31	9,5		
91133/102	0285 9	5	10,27	0,02	101	21	9,5		
91133/103	0286 6	5	15,07	0,03	101	31	9,5		
91133/122	0287 3	5	12,27	0,024	121	21	9,5		
91133/123	0288 0	5	18,02	0,036	121	31	9,5		
91136/062	0294 1	5	6,28	0,012	61	21	9,5		
91136/063	0295 8	5	9,18	0,018	61	31	9,5		
91136/082	0296 5	5	8,28	0,016	81	21	9,5		
91136/083	0297 2	5	12,13	0,024	81	31	9,5		
91136/102	0298 9	5	10,27	0,02	101	21	9,5		
91136/103	0299 6	5	15,07	0,03	101	31	9,5		
91136/122	0300 9	5	12,27	0,024	121	21	9,5		
91136/123	0301 6	5	18,02	0,036	121	31	9,5		
91154/062	0530 0	5	6,28	0,012	61	21	9,5		
91154/063	0531 7	5	9,18	0,018	61	31	9,5		
91154/064	0532 4	5	12,19	0,012	61	41	9,5		
91154/082	0533 1	5	8,28	0,016	81	21	9,5		
91154/083	0534 8	5	12,13	0,024	81	31	9,5		
91154/084	0535 5	5	15,97	0,032	81	41	9,5		
91154/102	0536 2	5	10,27	0,02	101	21	9,5		
91154/103	0537 9	5	15,03	0,03	101	31	9,5		
91154/104	0538 6	5	19,87	0,039	101	41	9,5		
91154/122	0539 3	5	12,27	0,024	121	21	9,5		
91154/123	0540 9	5	18,02	0,036	121	31	9,5		
91154/124	0541 6	5	23,77	0,047	121	41	9,5		
91154/126	0542 3	5	35,26	0,07	121	61	9,5		
91154/152	0543 0	5	15,26	0,03	151	201	9,5		
91154/153	0544 7	5	22,43	0,044	151	301	9,5		
91154/154	0545 4	5	19,61	0,059	151	41	9,5		
91154/156	0546 1	5	43,95	0,088	151	61	9,5		
91154/202	0547 8	5	20,25	0,04	201	201	9,5		
91154/203	0548 5	5	29,80	0,059	201	31	9,5		
91154/206	0549 2	5	54,44	0,116	201	61	9,5		

	REF.	COR COLOR COLOR	EAN 78.977.462	EMB. PKG. EMB.						
							cm			
				UN.	KG	M ³	L	P	A	
	91122/062	natural A/B	0023 7	5	6,28	0,012	61	21	9,5	
	91122/063		0029 9	5	9,18	0,018	61	31	9,5	
	91122/082		0024 4	5	8,28	0,016	81	21	9,5	
	91122/083		0030 5	5	12,13	0,024	81	31	9,5	
	91122/102		0025 1	5	10,27	0,02	101	21	9,5	
	91122/103		0031 2	5	15,07	0,03	101	31	9,5	
	91122/122		0026 8	5	12,27	0,024	121	21	9,5	
	91122/123		0635 2	5	13,33	0,026	121	31	7	
	91122/152		0027 5	5	15,26	0,03	151	21	9,5	
	91122/153		0033 6	5	22,43	0,044	151	31	9,5	
	91122/154		0136 4	5	29,61	0,059	151	41	9,5	
	91122/202		0028 2	5	20,25	0,04	201	21	9,5	
	91122/203		0034 3	5	29,8	0,059	201	31	9,5	
	91804/010	branca white blanca	0550 8	1	0,10	0,0004	17	17	1,4	
	91804/011		0551 5	1	0,25	0,001	20	20	1,4	
	91804/030	branca white blanca	0552 2	1	0,25	0,001	27	15,5	1,8	
	91804/040		0553 9	1	0,35	0,001	35	20	1,9	
	91804/001	branca white blanca	0244 6	1	0,005	0,0005	15	10	3	
	91804/002		0249 1	1	0,08	0,001	20	15	3,5	
	91804/003		0250 7	1	0,12	0,002	25	20	4,3	
	91804/004		0524 9	1	0,155	0,003	30	25	4,3	
	91809/001	preta black negra	1375 6	1	0,005	0,0005	15	10	3	
	91809/002		1377 0	1	0,08	0,001	20	15	3,5	
	91809/003		1379 4	1	0,12	0,002	25	20	4,3	
	91809/004		1381 7	1	0,155	0,003	30	25	4,3	
	91289/009	preta black negra	0118 0	1	0,20	0,001	28	10	1,8	
	91284/009	branca white blanca	0010 7	1	0,20	0,001	28	10	1,8	
	91622/016	natural	6809 1	1	2,72	0,008	59	13	11	
	91620/017		0948 3	1	4,40	0,011	75	13	11	
	91620/018		0949 0	1	7,10	0,019	149	13	10	
	91620/019		6704 9	1	5,44	0,015	118	13	10	
	91620/020		6705 6	1	8,16	0,023	177	13	10	
	91621/002		6706 3	1	4,00	0,011	87	13	10	
	91621/003		6707 0	1	5,34	0,012	87	13	11	
	91621/004		6708 7	1	7,11	0,017	116	13	11	
	91621/005		6709 4	1	9,34	0,025	173	13	11	
	91621/006		6800 8	1	10,68	0,025	173	13	11	
	91620/610		natural	1410 4	3	5,89	0,0219	56,2	24,6	15,9
	91900/071		natural	0950 6	10	10,33	0,049	47	28	37

	REF.	COR COLOR COLOR	EAN 78.977.462	EMB. PKG. EMB.					
							cm		
				UN.	KG	M ³	L	P	A
	91150/100	natural	1308 4	1	5,16	0,0136	100	19	7,2
	91150/110	natural	1309 1	1	6,30	0,0261	100	29	9
	91150/101	natural	1336 7	1	5,16	0,1265	56	22,6	100
	91150/111	natural	1337 4	1	6,30	0,0261	56	36	100
	91960/001	-	0193 7	1	25,00	0,080	149	89	6,0
	91221/017	-	0850 9	1	25,00	0,080	149	89	6,0
	91221/016	-	0665 9	1	25,00	0,080	149	89	6,0
	91961/001	-	6672 1	1	2,80	0,016	141	110	1,0
	91401/003	-	1340 4	1	0,3	0,001457	23,5	15,5	4
				30	9	0,040320	64	30	21
	91401/001		1	1	0,004128	32	21,5	6	
			10	10	0,040320	64	30	21	
	91401/005		1	5	0,025228	53	34	14	
			1356 5	1	8	0,034706	67	37	14
	91401/008		1	0,3	0,001457	23,5	15,5	4	
			1341 1	30	9	0,040320	64	30	21
			91402/003	1	1	0,004128	32	21,5	6
				10	10	0,040320	64	30	21
91402/001		1	5	0,025228	53	34	14		
		1352 7	1	8	0,034706	67	37	14	
91402/008		1	0,3	0,001457	23,5	15,5	4		
		1342 8	30	9	0,040320	64	30	21	
		91403/003	1	1	0,004128	32	21,5	6	
			10	10	0,040320	64	30	21	
	91403/001	1	5	0,025228	53	34	14		
		1353 4	1	8	0,034706	67	37	14	
	91403/005	1	0,3	0,001457	23,5	15,5	4		
		1358 9	30	9	0,040320	64	30	21	
	91403/008	1	1	0,004128	32	21,5	6		
		1346 6	10	10	0,040320	64	30	21	
	91404/001	1	5	0,025228	53	34	14		
		1354 1	1	8	0,034706	67	37	14	
	91404/005	1	1	0,004128	32	21,5	6		
		1359 6	10	10	0,040320	64	30	21	
	91404/008	1	2	0,005467	35,5	22	7		
		1360 2	10	20	0,050820	77	33	20	
	91400/010	1	10	0,039184	64	38	12		
		1361 9	1	10	0,039184	64	38	12	
91400/012	1	1	0,003364	32,5	23	4,5			
	1348 0	10	10	0,022440	55,00	34,00	12,00		
91400/020	1	1	0,003364	32,5	23	4,5			
	1349 7	10	10	0,037944	68	31	18		
91400/021	1	5	0,022440	55	34	12			
	1355 8	1	5	0,022440	55	34	12		
91400/025	1	1	0,002550	31	23,5	3,5			
	1347 3	10	10	0,029640	52	30	19		
91400/030	1	1	0,002550	31	23,5	3,5			
	1347 3	10	10	0,029640	52	30	19		



POLÍTICA DE PLANTIO

O consumo de derivados de madeira no mundo gira em torno de 500 milhões de metros cúbicos por ano.

Se todo esse consumo fosse suprido apenas por florestas produzidas pela Natureza, elas desapareceriam logo. As florestas plantadas com o objetivo específico de abate, para atender à demanda da indústria madeireira, são uma ótima alternativa para aliviar as pressões de consumo que ameaçam florestas naturais.

Tramontina Madeiras S.A. fabrica móveis e utilidades domésticas de madeira maciça, cuja matéria prima procede de florestas de produção de origem legal.

Os pinus em crescimento servem como elementos purificadores do ar, pois absorvem e fixam, em sua estrutura, o carbono muitas vezes presente na atmosfera – na forma de gás nocivo. O pinus também é um enriquecedor do solo, uma vez que raízes e troncos que apodrecem, somados às acidulas e restos de galhos que se decompõem na superfície, são elementos que agregam nutrientes a solos empobrecidos.

Por tudo isso, o plantio realizado por Tramontina permite à empresa fabricar produtos de alta qualidade não só preservando as florestas naturais, mas também ajudando a reduzir a poluição do ar e a melhorar a qualidade do solo nessas regiões.

Além disso, a empresa está envidando esforços para obter, através do FSC [Forest Stewardship Council], a certificação da floresta, comprovando que a madeira é obtida de florestas manejadas através de processos ecologicamente corretos.

PLANTING POLICY

The world consumes approximately 500 millions cubic meters of wood derivatives per year.

If all this were supplied solely by the natural forests, they would soon all disappear. The forests that are planted with the specific objective of cutting, to supply the demands from the lumber industry, are an excellent alternative to relieve the consumption pressures that endanger the natural forests.

Tramontina Madeiras S. A. manufactures furniture and household goods of solid wood made from raw materials that come from its own forest of 10 million trees. This provides a responsible ratio of 3 cubic meters of tree growth for each cubic meter used in the factory.

The growing pinus serve as air purifying elements, because they absorb carbon that may be present in the atmosphere as a hazardous gas and attach it to their structure. The pinus also enriches the soil as the roots and stumps rot and are aided by the contents and leftovers of branches that decompose on the surface, providing nutrients to impoverished soils.

Due to this, the planting performed by Tramontina, allows the company to manufacture quality products, not only preserving the natural forests.

Beside that, we are also helping to reduce the air pollution and improve the quality of the forest by the FSC [Forest Stewardship Council], proving that the wood is obtained from managed forests using ecologically correct processes.

POLÍTICA DE PLANTACIÓN

El consumo de derivados de madera en el mundo gira alrededor de 500 millones de metros cúbicos por año.

Si todo ese consumo fuese suplido apenas por florestas producidas por la naturaleza, ellas desaparecerían luego. Las florestas plantadas con un objetivo específico de abate, para atender a la demanda de la industria maderera, son una óptima alternativa para aliviar las presiones de consumo que amenazan florestas naturales.

La Tramontina Maderas S. A. fabrica muebles y utilidades domésticas de madera maciza, cuya materia prima proviene de sus propias áreas de forestación con 10 millones de árboles. Eso tiene como resultado una relación de crecimiento cómoda, de 3 metros cúbicos por cada metro cúbico serrado en la fábrica.

Los pinos en crecimiento sirven como elementos purificadores del aire, pues absorben y fijan en su estructura carbono, muchas veces presente en la atmósfera en la forma de gas nocivo. El pino también es un enriquecedor del suelo, una vez que raíces y troncos que apudrecen, sumados a las acidulas y restos de gajos que se decomponen en la superficie, son elementos que agregan nutrientes a los suelos empobrecidos.

Por estos motivos, la plantación realizada por Tramontina permite a la empresa fabricar productos de calidad, no apenas preservando las florestas naturales, sino también ayudando a reducir la contaminación del aire y a mejorar la calidad del suelo en esas regiones.

Además de eso, la empresa está envidando esfuerzos para obtener, a través do FSC [Forest Stewardship Council], la certificación de la floresta, comprobando que la madera es obtenida de florestas manejadas a través de procesos ecológicamente correctos.

TRAMONTINA

TRAMONTINA MADEIRAS S.A.

Rodovia Prefeito Hercio Alves Rodrigues,
RSC 471, Km 233 | CEP 96610-000
Encruzilhada do Sul | RS | Brasil
CNPJ 93.682.854/0001-86
Indústria Brasileira



TRAMONTINA.COM



/TRAMONTINA



/TRAMONTINA



/TRAMONTINA



@TRAMONTINAOFICIAL



/TRAMONTINA